

# **RANGE 2 3D SCANNER**

## **Quick Start Guide**

**V2.0**

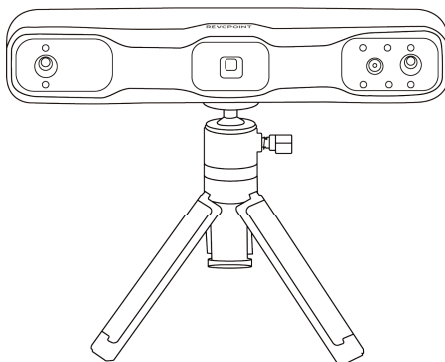

# **REVOPPOINT**

Thank you for choosing the Revopoint 3D scanner! Please carefully read this guide before your first scan.

Begin by downloading the **Revo Scan** software for your RANGE 2 3D Scanner. For Windows and macOS users, visit the Support section on Revopoint's website at [www.revopoint3d.com](http://www.revopoint3d.com) to download. Smartphone users, find **Revo Scan** on Google Play or the Apple App Store to download.

---

Please keep the scanner away from water and any other liquids, and avoid bashing the scanner.

This product's operating environment temperature range is 0°C to 40°C (32°F to 104°F). Please operate the product appropriately and only in situations limited to this temperature range.

---

# Contents

■ What's in the Box? .....	1
■ Product Profile .....	1
■ System Requirements .....	2
■ Scanner Connection .....	2
I. Connecting RANGE 2 to a PC via USB Cable .....	2
II. Connecting RANGE 2 to a PC via Wi-Fi .....	3
III. Connecting RANGE 2 to Android Phones via USB Cable .....	4
IV. Connecting RANGE 2 to Android or iOS Phones via Wi-Fi .....	5
■ Scanning Tips .....	6
■ Your First Scan .....	7
I. Your First Scan Using Revo Scan (PC) .....	7
II. Your First Scan Using Revo Scan (Android) .....	8
III. Your First Scan Using Revo Scan (iOS) .....	9
Sharing Models from a Phone to a PC .....	10
IC Warning .....	11
FCC Warning .....	11

# What's in the Box?

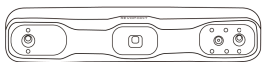

RANGE 2 3D Scanner



Phone Holder



RANGE 2 Quick Start Guide



USB Type-A to C Cable



Tripod

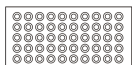

Markers



Power Bank Handle



Quick Release Plate



Screwdriver



USB Type-C Adapter

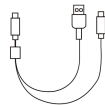

2-in-1 Mobile Cable

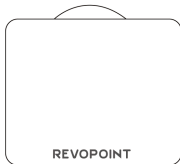

REVOPOINT Carrying Case

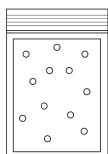

Magic Mat



Calibration Board X 4 (Optional Accessory)

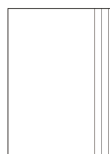

Large Calibration-board Sheet (Optional Accessory)

※ For reference only.

# Product Profile

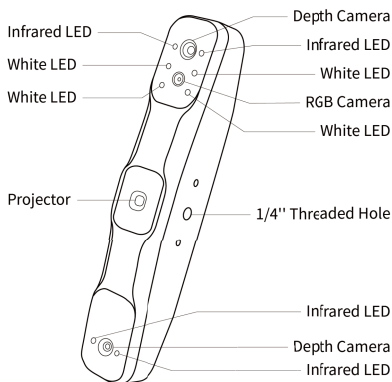
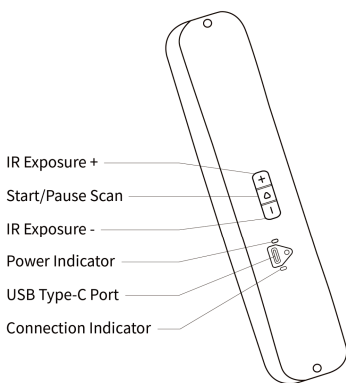

## System Requirements

Please download the Revo Scan software before your first scan. The system requirements are as follows:

Windows: Win 10/11 (64-bit) RAM: 8GB or better Processor: Intel Core i5 10th Gen or better	Android: Android 9.0 or better RAM: 6GB or better
Mac with Intel x86 chip: macOS 10.15 and models after Mac with Apple M1/M2 chip: macOS 11.0 and models after RAM: 8GB or better	iPhone: iPhone 8 Plus or models after iPad: 6th generation iPad or models after System Version: iOS 13.0 or better

## Scanner Connection

### Connection Modes

System Mode	PC		Phone	
	Windows	macOS	Android	iOS
USB	✓	✓	✓	✗
Wi-Fi	✓	✓	✓	✓

### I. Connecting RANGE 2 to a PC via USB Cable

**Step 1:** Connect the Tripod to the scanner.

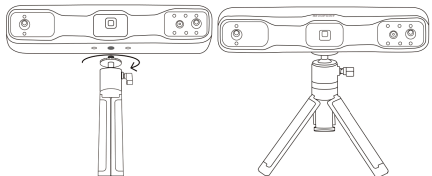

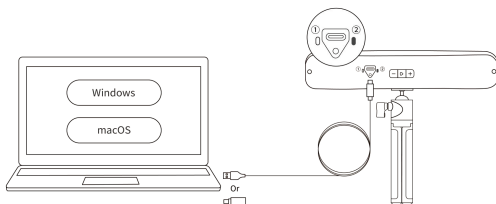

**Step 2:** Use the USB Type-A to C Cable to connect the scanner to a PC. When the scanner's indicator ② turns solid green, it's powered.

**Note:** If your PC does not have a USB Type-A port, use the USB Type-C Adapter.

**Step 3:** Open Revo Scan, when the software shows Scanner Connected and the scanner's indicator ① turns solid blue, it's ready.

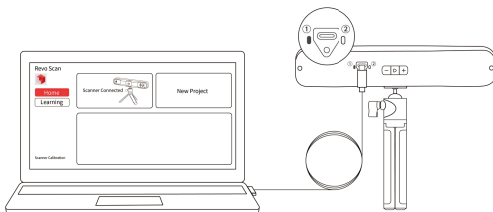

## II. Connecting RANGE 2 to a PC via Wi-Fi

**Step 1:** Screw the scanner onto the Power Bank Handle.

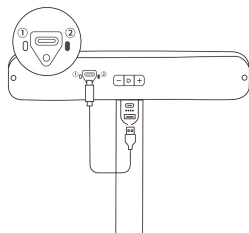
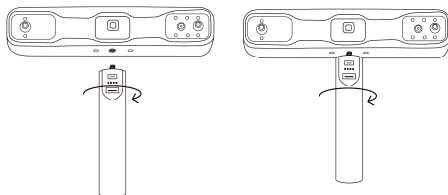

**Step 2:** Use the USB Type-A to C Cable to connect the scanner and Power Bank Handle. When the scanner's indicator ② turns solid green, it's powered.

**Step 3:** Search for a Wi-Fi network called **RANGE 2-REVO-XXXXXXX** in your PC's Wi-Fi settings, and connect (no password is required).

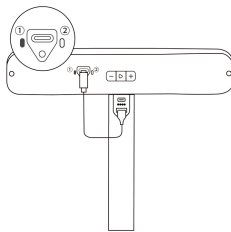
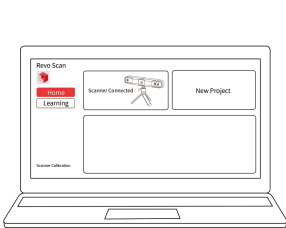
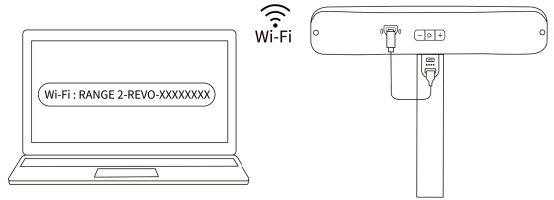

**Step 4:** Open Revo Scan, when the software shows Scanner Connected and the scanner's indicator ① turns solid blue, it's ready.

### III. Connecting RANGE 2 to Android Phones via USB Cable

**Step 1:** Attach the Quick Release Plate, Phone Holder, and Power Bank Handle to the scanner.

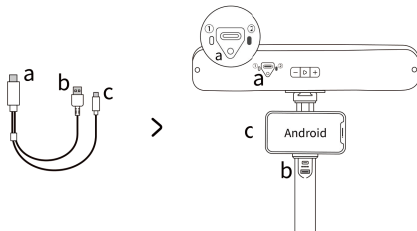
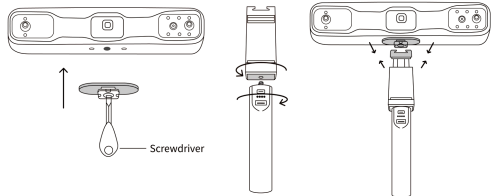

**Step 2:** Put a phone in the Phone Holder, and use the 2-in-1 Mobile Cable to connect to the ports shown. When the scanner's indicator ② turns solid green, it's powered.

**Note:** The 2-in-1 Mobile Cable can only be used to connect the scanner and phones.

**Step 3:** Open Revo Scan, when the software shows Scanner Connected and the scanner's indicator ① turns solid blue, it's ready.

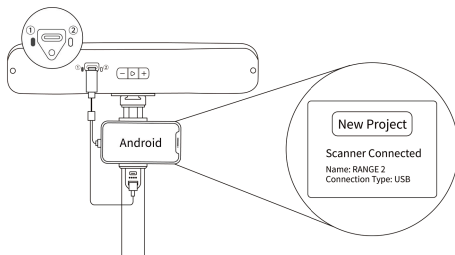

## IV. Connecting RANGE 2 to Android or iOS Phones via Wi-Fi

**Step 1:** Attach the Quick Release Plate, Phone Holder, and Power Bank Handle to the scanner.

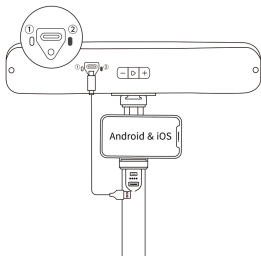
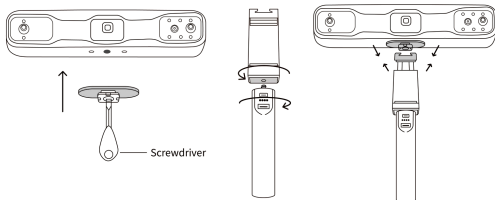

**Step 2:** Put a phone in the Phone Holder, and use the USB Type-A to C Cable or 2-in-1 Mobile Cable to connect the scanner to the Power Bank Handle. When the scanner's indicator ② turns solid green, it's powered.

**Step 3:** Search for a Wi-Fi network called **RANGE 2-REVO-XXXXXXX** in your smartphone's Wi-Fi settings, and connect (no password is required).

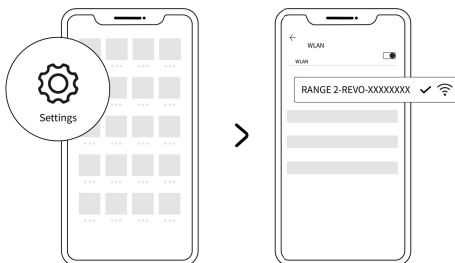



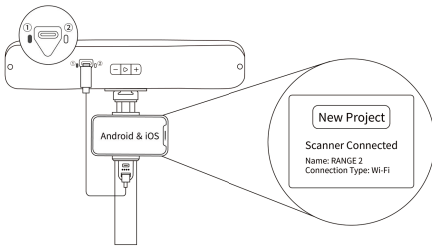

**Step 4:** Open Revo Scan, when the software shows Scanner Connected (iOS devices will show the scanning preview window) and the scanner's indicator ① turns solid blue, it's ready.

## Scanning Tips

- ① Please scan indoors and ensure only the object to be scanned is shown in the Depth Cameras' preview window. Use the Large Calibration-board Sheet to help if necessary. Ensure the object is evenly lit if you need a color model.
- ② Use scanning spray when scanning transparent, dark, and reflective objects.



**Note:** Scanning spray can be purchased from the Revopoint Store on our website.

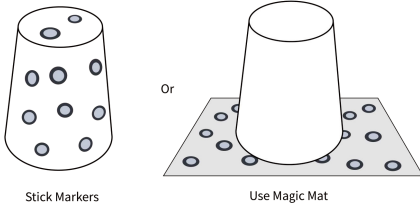

Stick Markers

Use Magic Mat

- ③ Please stick markers irregularly on the object's surface or use the Magic Mat when scanning featureless objects like balls and cylinders, and choose Marker Tracking in Scan Settings - Tracking Mode in Revo Scan.

- ④ Please aim the scanner at the object to be scanned, hold it steady and move slowly during your scan. The distance between the scanner and the object can be between 400 – 1300 mm. In the 3D scanning interface in Revo Scan, refer to the distance indicator bar to ensure an excellent distance between the scanner and the object.

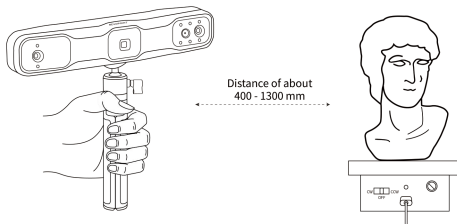

**Note:** The scanning accuracy may be affected if the scanner is bashed by accident. In this case, please get in touch with us to help you recalibrate the scanner with the Calibration Board. If the accuracy still cannot reach the standard accuracy after recalibration, please return the scanner for repair.

## Your First Scan





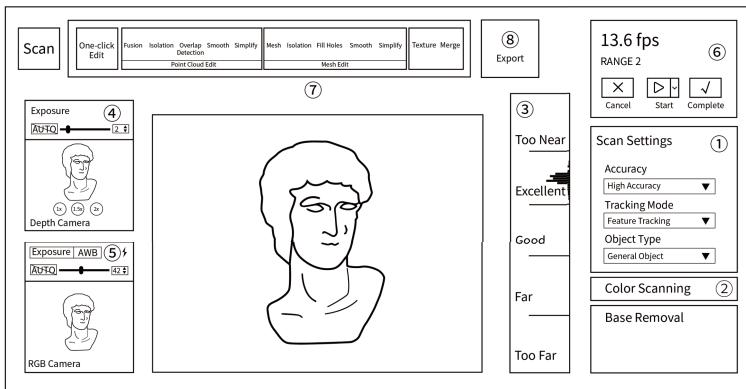



### I. Your First Scan Using Revo Scan (PC)

After the scanner is connected, click the **New Project** button on Revo Scan's Home Page, then set parameters and start your scan using the following steps:





※ Please refer to the interface of Revo Scan.

- ① Choose Accuracy, Tracking Mode, and Object Type according to your requirements.
- ② Toggle **Color Scanning** if you need a color model.
- ③ Move the scanner closer or further away from the object until the scanning distance indicator bar shows **Excellent** or **Good**.



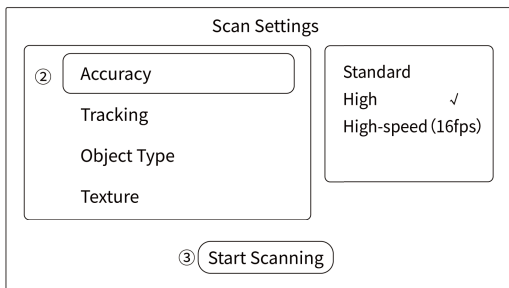

- ④ Click the  button for the Depth Cameras' exposure to be set automatically, or you can turn off the  exposure and change the exposure by dragging the slider until there are as few blue and red areas on the object in the Depth Camera preview window as possible.
- ⑤ You also must adjust the RGB Camera's exposure when doing a color scan. Click the  button for the exposure to be set automatically, or you can turn off the  exposure and adjust the exposure by dragging the slider until the object's color in the RGB preview window is clear and sharp.
- ⑥ Click the  button to begin your scan. While scanning, hold the scanner steady and move slowly. Try not to scan the same areas repeatedly. You can click the  button to stop and check your model anytime during your scan. If the model is incomplete, click the  button to continue your scan. Click the  button to finish the scan when the model is complete.
- ⑦ Click **One-click Edit** to process the model automatically, or manually edit the model using the Fusion, Mesh, Texture (only for color models) settings, and other tools if you need a more detailed model.
- ⑧ After post-processing, export the model in PLY, OBJ, or STL formats.

## II. Your First Scan Using Revo Scan (Android)

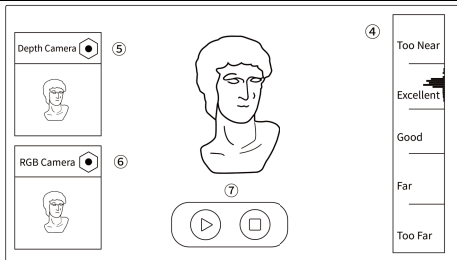





- ① Open Revo Scan on your phone and tap the **New Project** button.
- ② Choose Accuracy, Tracking Mode, and Object Type according to your needs. Choose **Color** in **Texture** if you need a color model.
- ③ Tap the **Start Scanning** button to enter the scanning preview window.
- ④ Move the scanner closer or further away from the object until the scanning distance indicator bar shows **Excellent** or **Good**.
- ⑤ Tap the  icon in the Depth Camera preview window to adjust the Depth Cameras' exposure until there are as few blue and red areas on the object in the preview window as possible.



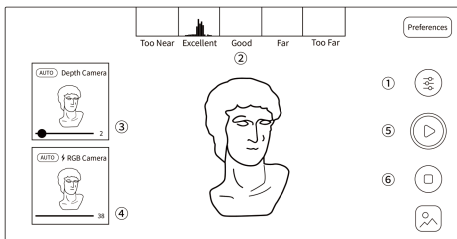



- ⑥ You must also adjust the RGB Camera's exposure when doing a color scan. Tap the  icon in the RGB Camera preview window and adjust the exposure until the object's color in the preview window is clear and sharp.
- ⑦ Tap the  icon to start scanning. While scanning, hold the scanner steady and move slowly. Try not to scan the same areas repeatedly. Tap the  button to finish the scan and enter the post-processing window when the scan is over.
- ⑧ Tap the  icon to fill holes in the model (optional).
- ⑨ Tap the **Post-processing** button for Fusing and Meshing. You can share the model to Revo Scan on your PC for more editing options. See **Sharing Models from a Phone to a PC** on page 10 of this guide for details.

### III. Your First Scan Using Revo Scan (iOS)



- ① Tap the  icon to choose Accuracy, Tracking Mode, and Object Type. Toggle **Color Scanning** if you need a color model.
- ② Move the scanner closer or further away from the object until the scanning distance indicator bar shows **Excellent** or **Good**.
- ③ Tap the  button for the Depth Cameras' exposure to be set automatically, or you can turn off the  exposure and change the exposure by dragging the slider until there are as few blue and red areas on the object in the Depth Camera preview window as possible.

- ④ You also must adjust the RGB Camera's exposure when doing a color scan. Tap the  button for the exposure to be set automatically, or you can turn off the  exposure and adjust the exposure by dragging the slider until the object's color in the RGB preview window is clear and sharp.
- ⑤ Tap the  button to start your scan. While scanning, hold the scanner steady and move slowly. Try not to scan the same areas repeatedly.
- ⑥ Tap the  button to finish the scan and enter the post-processing window when the scan is over.

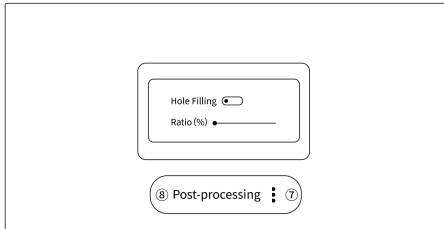

- ⑦ Tap the  icon to fill holes in the model (optional).
- ⑧ Tap the **Post-processing** button to automatically process the model. You can share the model to Revopoint Scan on your PC for more editing options.

## Sharing Models from a Phone to a PC

- ① Open Revopoint Scan on your PC and click the **New Project** button.
- ② Choose **File - Import from Phone** on the Menu Bar.
- ③ Open Revopoint Scan on your phone and find the project to transfer.
- ④ Tap the share icon and enter the share page.
- ⑤ Enter the code or scan the QR code displayed on the PC.
- ⑥ Wait for the project to be transferred.

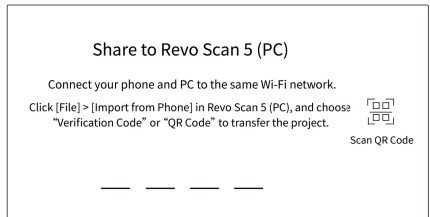

**Note:** The phone and PC must be connected to the same network while transferring.

To learn more scanning skills, go to the Download page in the Support section on Revopoint's website, [www.revopoint3d.com](http://www.revopoint3d.com), to get the latest **Quick Start Guide** and **User Manual**. You can also follow our **YouTube account, Revopoint 3D**, for tutorial videos. This content is subject to change. Please refer to the latest version.

## IC Warning

This device complies with Industry Canada's licence-exempt RSS standard(s). Operation is subject to the following two conditions:

- (1) this device may not cause interference, and
- (2) this device must accept any interference, including interference that may cause undesired operation of the device.

This Class B digital apparatus complies with Canadian ICES-003.

IC RF Statement:

When using the product, maintain a distance of 20cm from the body to ensure compliance with RF exposure requirements.

## FCC Warning

This device complies with part 15 of the FCC Rules. Operation is subject to the following two conditions:

- (1) This device may not cause harmful interference, and
- (2) this device must accept any interference received, including interference that may cause undesired operation.

Any Changes or modifications not expressly approved by the party responsible for compliance could void the user's authority to operate the equipment.

**Note:** This equipment has been tested and found to comply with the limits for a Class B digital device, pursuant to part 15 of the FCC Rules. These limits are designed to provide reasonable protection against harmful interference in a residential installation. This equipment generates uses and can radiate radio frequency energy and, if not installed and used in accordance with the instructions, may cause harmful interference to radio communications. However, there is no guarantee that interference will not occur in a particular installation. If this equipment does cause harmful interference to radio or television reception, which can be determined by turning the equipment off and on, the user is encouraged to try to correct the interference by one or more of the following measures:

- Reorient or relocate the receiving antenna.
- Increase the separation between the equipment and receiver.
- Connect the equipment into an outlet on a circuit different from that to which the receiver is connected.
- Consult the dealer or an experienced radio/TV technician for help.

This equipment complies with FCC radiation exposure limits set forth for an uncontrolled environment.

This equipment should be installed and operated with minimum distance 20cm between the radiator & your body.



**Follow Us:**



**Contact Us:**



Scan the QR code left with your phone and contact us for help.